

C60-EXT-120

THIS DRAWING AND ALL DATA INCLUDED IS THE PROPERTY OF APPLIED SCIENTIFIC INSTRUMENTATION AND THE INFORMATION CONTAINED HEREIN IS FOR GENERAL PRESENTATION PURPOSES ONLY AND MAY CHANGE AT ANY TIME. CONTACT ASI OR A FACTORY REPRESENTATIVE FOR PROJECT SPECIFIC ENGINEERING.

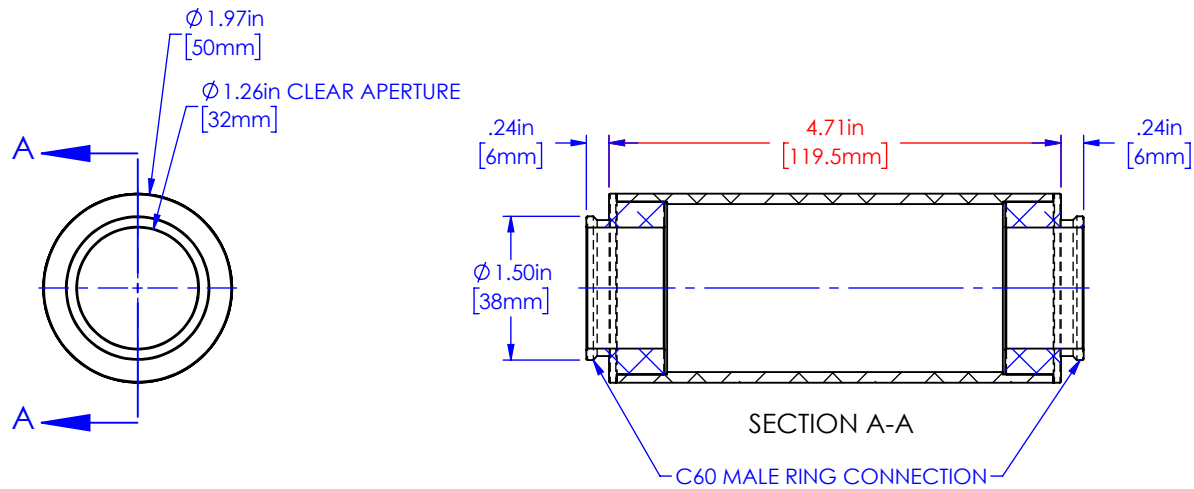

PROPRIETARY AND CONFIDENTIAL

THE INFORMATION CONTAINED IN THIS DRAWING IS THE SOLE PROPERTY OF APPLIED SCIENTIFIC INSTRUMENTATION. ANY REPRODUCTION IN PART OR AS A WHOLE WITHOUT THE WRITTEN PERMISSION OF APPLIED SCIENTIFIC INSTRUMENTATION IS PROHIBITED.

APPLIED SCIENTIFIC INSTRUMENTATION

29391 W ENID RD
EUGENE, OR 97402-9533
PHONE: (541)461-8181
FAX: (541)461-4018

**UNLESS OTHERWISE SPECIFIED
DIMENSIONS ARE IN INCHES**

.xx ± .01
.xxx ± .005
.xxxx ± .0002
FRACTIONS ± 1/32
ANGLES ± 1°

DESCRIPTION

120mm EXTENSION TUBE ASSEMBLY

DRAWN BY/DATE

M.ANTHONY 2/22/24

CHECKED BY/DATE

V.MARSO 2/22/24

SCALE

1:2

REV

-

MATERIAL

6061,
ANODIZED BLK

DRAWING #

C60-EXT-120